

FODIS (Fiber Optic Distribution System) 19" Compact System 1HU/3HU

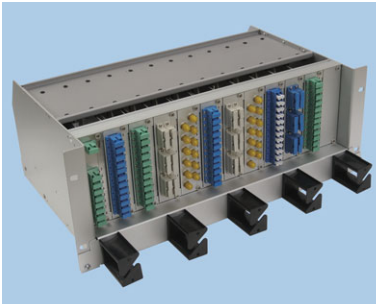

euroclust FODIS is a user friendly optical fiber patch system with conventional couplings. The application of such a system is in rooms where maximum flexibility is required (typically in computer centres, subnetworks). Two subrack types are available:

- a 19" subrack of 1HU for up to 3 compact plug in modules with max 36/72 fibers or
- a 19" subrack of 3HU+1HU with an integrated overlength tray of 1HU with cable routing of max 144/288 fibers

The whole system consists basically of:

- a subracks with cable guidance
- different types of compact plug in modules
- accessories

The hole patterns of the compact modules are according to DIN IEC60297-3 and the subrack is divided in 84 SU for the installation in 19" racks. An overlength tray of 1HU can be pulled out to the rear, takes up the filled loose tube reserve loops and serves to fix the optical fibre cables. 5 black plastic cable clamps are mounted at the front side of the overlength tray to secure the horizontal guidance of the fiber optic cables in compliance with the minimum bending radius. A guiding cable tray with slots for Velcro fasteners can also be used instead of the 5 cable clamps.

19" FODIS Subrack 3HU with integrated overlength tray 1U

Aluminium subrack for 19" racks

Features:

- 19" component chassis 3HU , 84SU, 12x7
- accomodates max.12 compact plug in modules
- max capacity 144/288 fibers
- housing made of anodized aluminium
- pre-assembled guide rails for compact modules (7SU)

Optional:

- Aluminium cover for 19" subrack
- Loose tube divider available either 12x left or 12x right, steel plate powder coated, jet black matt, RAL9005
- Aluminium cable entry plate blind
- Aluminium cable entry plate streight for one PG16 and one PG9 gland
- Aluminium cable entry plate angular for one PG16 gland
- Mini-Flex protective tube 15 m white OFPT-S-5.0-3.1-PP

Aluminium 1U integrated overlength tray

Features:

- can be pulled out to the rear
- takes up the loose tube reserve loops
- drawer can be extended backwards
- 5 black plastic cable clamps or guiding cable tray can be mounted directly at the front side of the overlength tray

Patchcable guidance

Features:

- easy patchcord organization height 1HU

19" FODIS Subrack 1HU

Features:

- accomodates 3 compact modules
- max capacity 36/72 fibers
- material steel sheet 1,5mm
- color powder coated RAL 7035 light grey
- including 2 cable guidance brackets and cover
- with front labelling plate which can be mounted by snap latches

Description

Subrack 1HU for 3 compact modules
Labelling plate with 2 snap latches

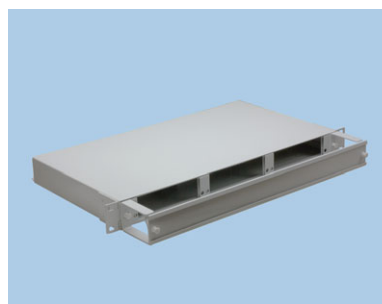

* 1SU Sub-Unit =5,08mm 1HU Height-Unit = 44,45mm

Article Number

EC03.201000.010

EC03.201000.011

FODIS (Fiber Optic Distribution System) 19" Compact System 3U

Technical data:

- Subrack with overlength tray and mounted cable clamps
- 483 x 178x 350 mm
- Material: Aluminium, cable clamp PE Polyethylene
- Colours: metallic, cable clamp black
- Packing unit: 1 piece



Description

Subrack with overlength tray and Patchcord guidance open
Subrack with overlength tray and Patchcord guidance open with cover
Cover for Subrack

Article Number

EC03.201000.001
EC03.201000.002
EC03.201000.003

Accessories for Subrack

Description

Blind plug for front panel 7SU/3 HU
Loose tube divider
Cable entry plate straight for 1 PG16 and 1 PG9 gland
Cable entry plate angular for 1 PG16 gland

Article Number

EC03.202000.001
EC03.201010.001
EC03.201020.001
EC03.201020.001

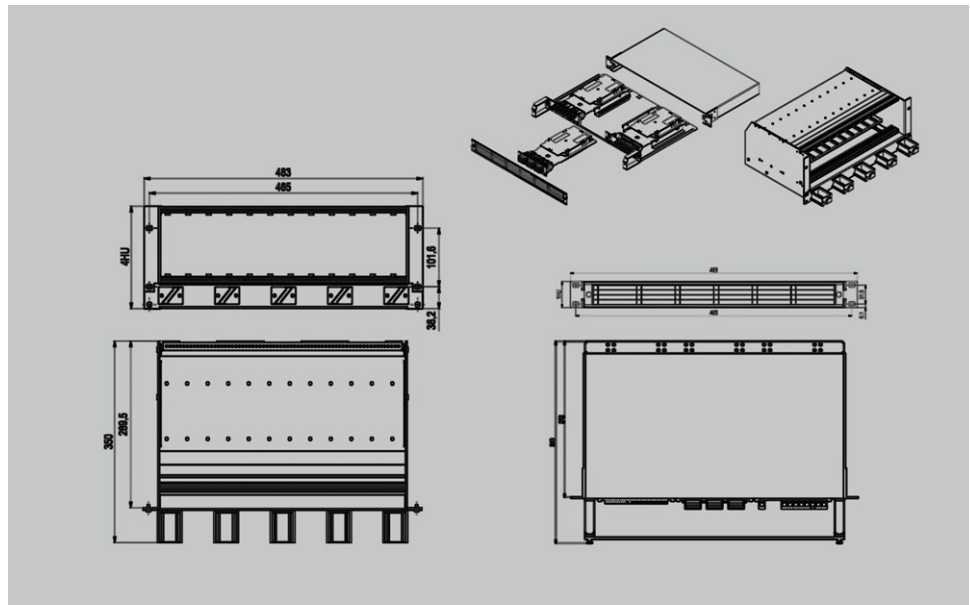

FODIS Compact Plug in modules

Features:

- width 7 SU height 3 HU
- Aluminium front plate anodized with channel numbering
- accomodates max 12 adapters /24 fibers of different types
- splicing cassettes can be equipped either with heat shrink or sandwich splice protectors
- Integrated neck collar screws for mounting the module in the subrack
- Simple and easy front mounting
- Aluminium-module carrier with splice cassette and overlength cassette

Optional:

- completely equipped with mounted adapters and inserted Pigtails
- Pigtails are protected by lockable overlength and splicing cassettes
- Pigtails in splice cassettes are coloured (primary and secondary according to the DIN VDE 0888 part 3 or IEC 60794-2 colour code)
- Pigtails are inserted into the splice cassette, dismantled (250µm) and ready for splicing

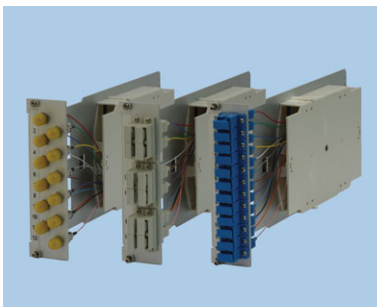

FODIS (Fiber Optic Distribution System) 19" Compact System

Compact Module 7SU 12 FC H-Hole



empty and with mounted adapters

Plug-in modul empty	
with mounted adapter Type	
FC round	APC
FC round	UPC
FC round	MM

Article Number
EC03.202010.003

EC03.202020.003
EC03.202023.003
EC03.202026.003

with mounted adapters and inserted Pigtaills

Plug-in modul with holders, adapters and inserted colored Pigtaills	
SM9/125	APC
SM9/125	UPC
MM50/125	OM2
MM50/125	OM3
MM50/125	OM3+
MM62,5/125	OM1

Article Number

with holder for 12 shrink splice protectors *	EC03.202021.003
	EC03.202024.003
	EC03.202027.003
	EC03.202030.003
	EC03.202033.003
	EC03.202036.003

Article Number

with holder for 12 crimp splice protectors *	EC03.202022.003
	EC03.202025.003
	EC03.202028.003
	EC03.202031.003
	EC03.202034.003
	EC03.202037.003

Compact Module 7SU 12 SC SX



empty and with mounted adapters

Plug-in modul empty	
with mounted adapter Type	
SC Simplex plastic	APC green
SC Simplex plastic	UPC blue
SC Simplex plastic	MM beige

Article Number
EC03.202010.001

EC03.202020.001
EC03.202023.001
EC03.202026.001

with mounted adapters and inserted Pigtaills

Plug-in modul with holders, adapters and inserted colored Pigtaills	
SM9/125	APC
SM9/125	UPC
MM50/125	OM2
MM50/125	OM3
MM50/125	OM3+
MM62,5/125	OM1

Article Number

with holder for 12 shrink splice protectors *	EC03.202021.001
	EC03.202024.001
	EC03.202027.001
	EC03.202030.001
	EC03.202033.001
	EC03.202036.001

Article Number

with holder for 12 crimp splice protectors *	EC03.202022.001
	EC03.202025.001
	EC03.202028.001
	EC03.202031.001
	EC03.202034.001
	EC03.202037.001

Compact Module 7SU 6 SC DX

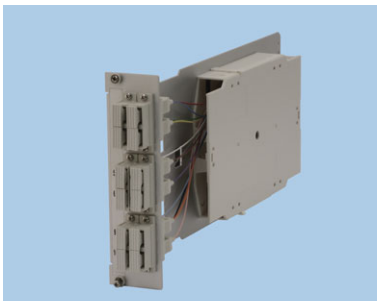

empty and with mounted adapters

Plug-in modul empty	
with mounted adapter Type	
SC Duplex plastic	APC green
SC Duplex plastic	UPC blue
SC Duplex plastic	MM beige

Article Number
EC03.202010.002

EC03.202020.002
EC03.202023.002
EC03.202026.002

with mounted adapters and inserted Pigtaills

Plug-in modul with holders, adapters and inserted colored Pigtaills	
SM9/125	APC
SM9/125	UPC
MM50/125	OM2
MM50/125	OM3
MM50/125	OM3+
MM62,5/125	OM1

Article Number

with holder for 12 shrink splice protectors *	EC03.202021.002
	EC03.202024.002
	EC03.202027.002
	EC03.202030.002
	EC03.202033.002
	EC03.202036.002

Article Number

with holder for 12 crimp splice protectors *	EC03.202022.002
	EC03.202025.002
	EC03.202028.002
	EC03.202031.002
	EC03.202034.002
	EC03.202037.002

* shrink and crimp protectors are not included, they must be ordered separately

FODIS (Fiber Optic Distribution System) 19" Compact System 3U

Compact Module 7SU 12 ST H-Hole

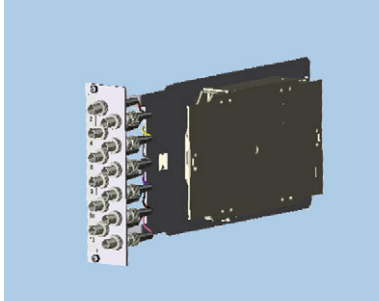

empty and with mounted adapters

Plug-in modul empty		
with mounted adapter Type		
ST H-Hole metal	APC	
ST H-Hole metal	UPC	
ST H-Hole metal	MM	

<i>Article Number</i>
EC03.202010.004
N/A
EC03.202023.004
EC03.202026.004

with mounted adapters and inserted Pigtails

Plug-in modul with holders, adapters and inserted colored Pigtails	<i>Article Number</i>	<i>Article Number</i>
SM9/125 APC	with holder for 12 shrink splice protectors *	with hoder for 12 crimp splice protectors *
SM9/125 UPC	EC03.202021.004	EC03.202022.004
MM50/125 OM2	EC03.202024.004	EC03.202025.004
MM50/125 OM3	EC03.202027.004	EC03.202028.004
MM50/125 OM3+	EC03.202030.004	EC03.202031.004
MM62,5/125 OM1	EC03.202033.004	EC03.202034.004
	EC03.202036.004	EC03.202037.004

Compact Module 7SU 12 LC DX

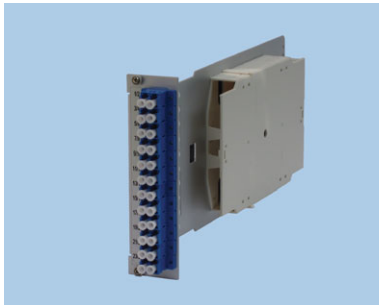

empty and with mounted adapters

Plug-in modul empty		
with mounted adapter Type		
LC Duplex plastic	APC green	
LC Duplex plastic	UPC blue	
LC Duplex plastic	MM beige	

<i>Article Number</i>
EC03.202010.007
EC03.202020.007
EC03.202023.007
EC03.202026.007

with mounted adapters and inserted Pigtails

Plug-in modul with holders, adapters and inserted colored Pigtails	<i>Article Number</i>	<i>Article Number</i>
SM9/125 APC	with holder for 12 shrink splice protectors *	with hoder for 12 crimp splice protectors *
SM9/125 UPC	EC03.202021.006	EC03.202022.006
MM50/125 OM2	EC03.202024.006	EC03.202025.006
MM50/125 OM3	EC03.202027.006	EC03.202028.006
MM50/125 OM3+	EC03.202030.006	EC03.202031.006
MM62,5/125 OM1	EC03.202033.006	EC03.202034.006
	EC03.202036.006	EC03.202037.006

Compact Module 7SU 12 E2000

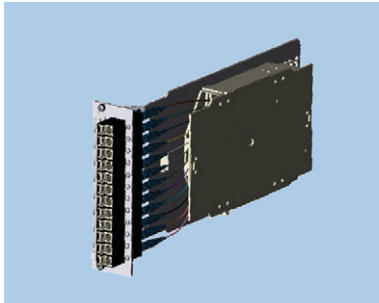

empty and with mounted adapters

Plug-in modul empty		
with mounted adapter Type		
E2000 Simplex	APC green	
E2000 Simplex	UPC blue	
E2000 Simplex	MM beige	

<i>Article Number</i>
EC03.202010.005
EC03.202020.005
EC03.202023.005
EC03.202026.005

with mounted adapters and inserted Pigtails

Plug-in modul with holders, adapters and inserted colored Pigtails	<i>Article Number</i>	<i>Article Number</i>
SM9/125 APC	with holder for 12 shrink splice protectors *	with hoder for 12 crimp splice protectors *
SM9/125 UPC	EC03.202021.005	EC03.202022.005
MM50/125 OM2	EC03.202024.005	EC03.202025.005
MM50/125 OM3	EC03.202027.005	EC03.202028.005
MM50/125 OM3+	EC03.202030.005	EC03.202031.005
MM62,5/125 OM1	EC03.202033.005	EC03.202034.005
	EC03.202036.005	EC03.202037.005

* shrink and crimp protectors are not included, they must be ordered separately

FODIS (Fiber Optic Distribution System) 19" Compact System 3U

Compact Module 7SU 12 SC SX/MPO empty and with mounted adapters
empty and with mounted adapters

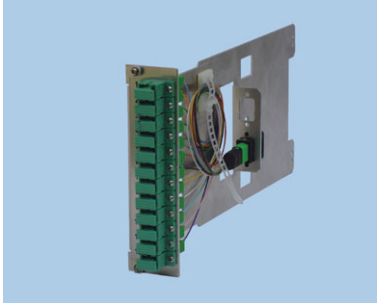

Plug-in modul empty
with mounted adapter Type
SC Simplex plastic APC
SC Simplex plastic UPC
SC Simplex plastic MM

Article Number
EC03.202010.006
EC03.202020.006
EC03.202023.006
EC03.202026.006

with mounted adapters and SC Pigtaills with MPO connector inserted in MPO adapter
Article Number

Plug-in modul with adapters and
colored Pigtaills with MPO connector
SM9/125 APC
SM9/125 UPC
MM50/125 OM2
MM50/125 OM3
MM50/125 OM3+
MM62,5/125 OM1

EC03.202080.006
EC03.202081.006
EC03.202082.006
EC03.202083.006
EC03.202084.006
EC03.202085.006

Compact Module 7SU 12 LC DX/MPO
empty and with mounted adapters

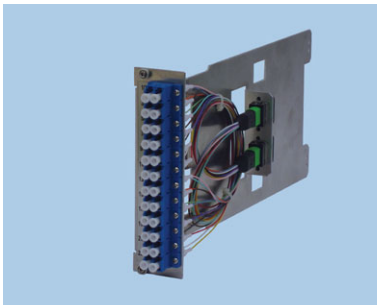

Plug-in modul empty
with mounted adapter Type
LC Duplex plastic APC green
LC Duplex plastic UPC blue
LC Duplex plastic MM beige

Article Number
EC03.202010.008
EC03.202020.008
EC03.202023.008
EC03.202026.008

with mounted adapters and LC Pigtaills with MPO connector inserted in MPO adapter
Article Number

Plug-in modul with adapters and
colored Pigtaills with MPO connector
SM9/125 APC
SM9/125 UPC
MM50/125 OM2
MM50/125 OM3
MM50/125 OM3+
MM62,5/125 OM1

EC03.202080.008
EC03.202081.008
EC03.202082.008
EC03.202083.008
EC03.202084.008
EC03.202085.008

Compact Splitter Module 7SU

1:8 SC SX with mounted adapters and splitter



with mounted adapter Type + splitter
SC Simplex plastic APC green
SC Simplex plastic UPC blue

Article Number
Splitter ratio equal split
EC03.202040.003
EC03.202048.003

1:16 SC SX/LC DX with mounted adapters and splitter

with mounted adapter Type + splitter
LC Duplex plastic APC green
LC Duplex plastic UPC blue

Article Number
Splitter ratio equal split
EC03.202040.004
EC03.202048.004

